

# Reading Material for **KHOA Production** Under PMFME Scheme



**AATMANIRBHAR BHARAT**

**National Institute of Food Technology Entrepreneurship and Management**

Deemed to be University (De-novo Category) under Section 3 of the UGC Act, 1956  
An Autonomous Institution under Ministry of Food Processing Industries, Government of India  
Plot no 97, Sector 56, HSIIDC, Industrial Estate, Kundli, Sonapat, Haryana – 131028  
Website: [www.niftem.ac.in](http://www.niftem.ac.in), Email: [pmfmecell@niftem.ac.in](mailto:pmfmecell@niftem.ac.in), Contact: 0130-2281089

## Contents

### Chapter – 1: Raw Material

1.1	Introduction.....	04
1.2	Dairy Industry in India.....	04
1.3	Insight on value-added product.....	05
1.4	Export-import opportunities.....	05
1.5	Key deterrents to the growth of the market.....	05
1.6	Need for Processing Milk.....	06
1.7	Composition of Milk.....	06
1.8	Nutritional Value of Milk.....	06

### Chapter – 2: Processing and Machinery

2.1	Introduction.....	08
2.2	Market Size of Khoa based products .....	09
2.3	Khoa as a main ingredient.....	09
2.4	Classification of khoa .....	10
2.5	Khoa Processing Flow Chart.....	10
2.6	SOP for khoa manufacturing.....	10
2.7	Ideal Sensory Quality.....	11
2.8	Yield.....	11
2.9	Bureau of Indian Standards (BIS) requirements for Khoa.....	11

### Chapter – 3: Packaging

3.1	Selection of packing material for khoa packing.....	15
3.2	Shelf life of khoa .....	15

### Chapter – 4: Food Safety Regulations and Standards

4.1	Registration and licensing.....	16
4.2	Hygiene, sanitary and good manufacturing practices (GMP).....	17
4.3	Packaging and labelling.....	20
4.4	Coding and labelling of packing material.....	21
4.5	Exemption from labelling requirement.....	22
4.6	Date of manufacturing or packing.....	22
4.7	Documentation and record keeping.....	23

4.8 How to keep record.....23

**Chapter - 5: Cleaning, CIP and Effluent Treatment**

5.1 Tanker washing.....24

5.2 Crate washing.....24

5.3 CIP of raw milk tanks/multipurpose vat etc.....24

5.4 Effluent Treatment Plant.....25

5.5 Plant performance and monitoring.....25

5.6 Environmental Management System: Implementation and operation.....26

# Chapter – 1

## Raw Material

### 1.1 Introduction

Milk, liquid secreted by the mammary glands of female mammals to nourish their young for a period beginning immediately after birth. The milk of domesticated animals is also an important food source for humans, either as a fresh fluid or processed into a number of dairy products such as butter and cheese (<https://www.britannica.com>). Milk is a nutritious choice as it provides nine essential nutrients our body needs. Milk contains essential nutrients like high-quality protein, calcium, vitamin D and more. These nutrients help our bodies function properly. For example: Protein helps build and repair muscle tissue Calcium and vitamin D helps build and maintain strong bones and teeth Milk also contains B vitamins, which can help your body convert food into energy.

### 1.2 Dairy Industry in India

India is leading milk producing country in the world, accounting for 19 percent of the global market share and expected to grow at compound annual growth rate (CAGR) of 14.8% between FY 2018 – 2023. As per fiscal year 2019, milk production in India amounted to about 187 million metric tons. As per FY – 2018, around 81% of the Indian dairy and milk processing market comes under unorganized sector, where milk is processed in unhygienic infrastructure, which affects the overall quality of milk and milk-based products. Consumption patterns of liquid milk at the farm level and less infrastructure for processing is the main reason for low value addition of milk. The demand for value added products especially traditional dairy products is increasing day by day and the dairy industry of the country is trying to meet the present demand.

Uttar Pradesh, Rajasthan and Gujarat are the major milk producing states in India. Uttar Pradesh is the largest milk-producing state, as it has the highest buffalo population and the second-highest cattle population in the country. Majority of the rural population in this state is engaged in livestock nurture and dairy farming. Gujarat holds several cooperative dairy unions, milk cooperative societies and private dairy plants, which play vital roles in the production of milk and milk-based products in the state.

### 1.3 Insight on value-added product

Apart from processed liquid milk, Indian dairy and milk processing industry generates revenue from several value-added products such as butter, curd, paneer, ghee, whey, flavoured milk, ultra-high temperature (UHT) milk, cheese, yogurt, dairy whitener and milk powder. During the FY 2016 – 2020, the market size of dairy ingredients is expected to grow by around 14%.

### 1.4 Export-import opportunities

The export of dairy products from India has increased to countries like Bhutan, Afghanistan, Canada, Egypt, and the United Arab Emirates. India has also imported a significant number of dairy products from countries like France, New Zealand, Ireland, France, Ukraine, and Italy.

### 1.5 Key deterrents to the growth of the market

Despite having a significant livestock base of milch animals, India lacks in terms of good processing facility and availability of cold storages which results in wastage of dairy output. Lack of sufficient storage facilities and inefficient distribution channels are hampering the growth of the Indian dairy and milk processing industry.

Sufficient quantity and good quality of feed and fodder are required for proper animal rearing and milk production. Improper droughts and flood management affect the production of fodder in India. Deficiency of proper feed and fodder for milch animals, due to high usage of agricultural crop residues by producers of fibreboard, paper, and liquid fuels, affect its availability for dairy production and milk processing.

#### Dairy marketing channels in India

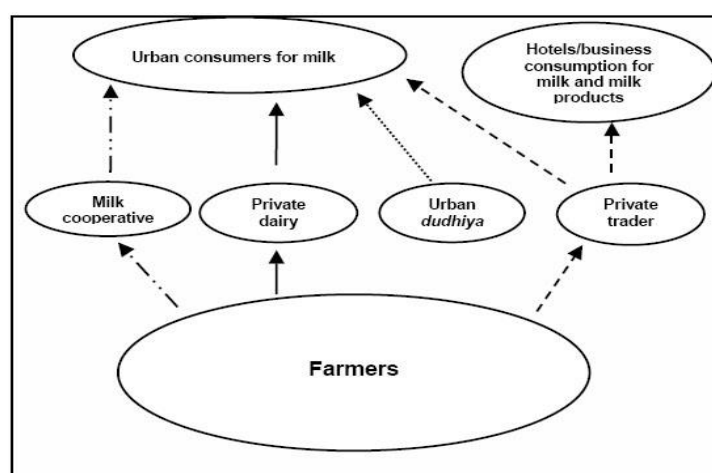

Reference: FAO

## 1.6 Need for Processing Milk

Milk is considered wholesome food mainly because of its high nutritive value. It has to be processed to;

- Increase the shelf life, because it is highly perishable.
- Prepare value added products like peda, dahi, cheese, paneer, butter, ghee, AMF, flavoured milk, cheese, and yogurt, dairy whitener, milk powder etc. and many more dairy based products, for a good health.
- Make business out of it, create job opportunities, consequently building financially strong Nation.

## 1.7 Composition of Milk

Milk composition varies with species, breed (Holstein, Jersey), feed, and the stage of lactation. As per FSSAI, “Milk is a whole, fresh, clean lacteal secretion obtained by complete milking of one or more healthy milch animals excluding that obtained within 15 days before calving or 5 days after calving. Market milk must possess the pre-determined percentage of milk fat and SNF (Solid Not Fat).”

Milk of different classes and types must conform to the standards laid down by FSSAI. Mixed milk means a combination of the milk from cow and buffalo or any other milch animal. The combination also should at par with FSSAI standards.

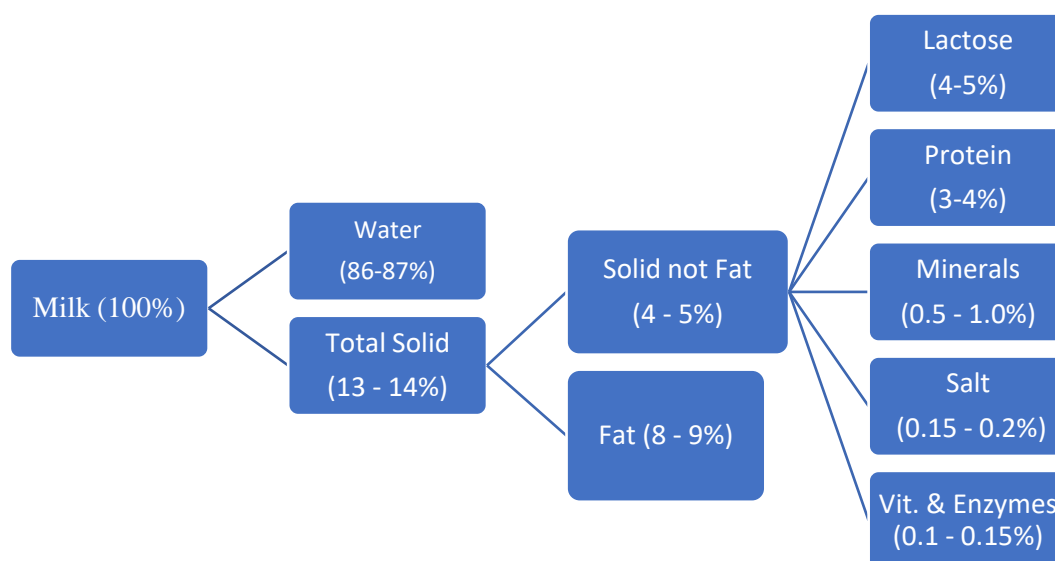

## 1.8 Nutritional Value of Milk

**Table: Nutritional values of milk**

<b>Nutritional Factor</b>	<b>Description</b>	<b>Energy Value</b>
Protein	Milk protein is casein, a high-quality protein. All essential amino acids are present in Milk.	4.1 kCal/g
Minerals	Milk contains phosphorus and calcium.	
Vitamins	Milk contains vitamins A, D, thiamine, and riboflavin.	
Fat	Milk fat is responsible of good flavor and physical properties. The fat content in cow milk is generally from 3.5 to 4.5 %	9.3 kCal/g
Lactose	Lactose is the sugar component of milk and it supply energy.	4.1 kCal/g

## Chapter – 2

### Processing and Machinery

#### 2.1 Introduction

Indian traditional sweetmeats (sweets / mithai) are very popular in our country and worldwide. Around 50% milk produced in India is converted to traditional Indian dairy products. Several types of sweets are prepared in different parts of country and categorized by different name and taste. Mostly, khoa and channa are used for the preparation of sweets. Khoa based sweets are peda, burfi, kalakand, milk cake etc. while channa based sweets are Rasogolla, Rasomalai, Sandesh etc. In addition to this, few sweets were prepared with the help of Chhana and khoa like Kala-Jamun, Pantooa etc.

Type of products	End products
Chhana- based sweets	Rasogolla, sandesh, pantooa, rasomalai, cham-cham, chhana murki, rajbhog, chhanapodo, etc.
Khoa-based sweets	Kulfi, rabri, basundi, burfi, peda, gulabjamun, kalakand, khurchan, dharwad peda, kunda,

Khoa is a heat desiccated products and is the base material for most of the sweets prepared by *halwais*. As per Food Safety and Standards Regulations (FSSR), 2011 Khoa by whatever name it is sold such as Khoa or Mawa or any other region-specific popular name means the product obtained by partial removal of water from any variant of milk with or without added milk solids by heating under controlled conditions. The product shall conform to the compositional specifications provided in the table below:

Parameter	Khoa
Total solids, minimum, %, (m/m)	55.0
Milk fat, minimum, %, (m/m), dry matter basis	30.0
Total ash, maximum, %, (m/m)	6.0
Titrateable acidity (as % lactic acid), maximum, %	0.9

It shall be free from added starch and added sugar. The extracted fat from Khoa shall meet the standards for Reichert Meissl value, Polenske value and Butyro-refractometer reading as prescribed for ghee.



## 2.2 Market Size of Khoa based products:

Nearly half of the milk produced in India (50-55%) is utilized for the manufacture of traditional dairy based sweets / products. A large proportion of the milk is converted into indigenous dairy products such as khoa & khoa based sweets (codex Alimentarius 2019).

Khoa is also known as Khoya, Kava and Mawa. Out of India’s annual milk production of 190 million tonnes (MT), around 10-15 MT of khoa is producing annually. With a price of Rs 250 per kg, the khoa market size would be worth Rs 50,000 crore. Uttar Pradesh is the leading khoa producing state having a share of 36% (out of total khoa production in India). The estimated market size of khoa based sweets is 520 billion INR. As per Protein Foods & Nutrition Development Association of India (PFNDAI), total sweets export from India was Rs 750 crores in 2019 of which bulk was traditional sweets.

## 2.3 Khoa as a main ingredient

Traditional dairy based sweets based on khoa containing all the milk solids which is good in protein, minerals and energy giving fat and lactose. Khoa is having high commercial significance because of its usages in several types of sweet preparations. Khoa based sweets have religious importance as they are offered as “Prasad” during worship of God in the temples like peda, burfi, kalakand etc. Some of the khoa based sweets are presented below;

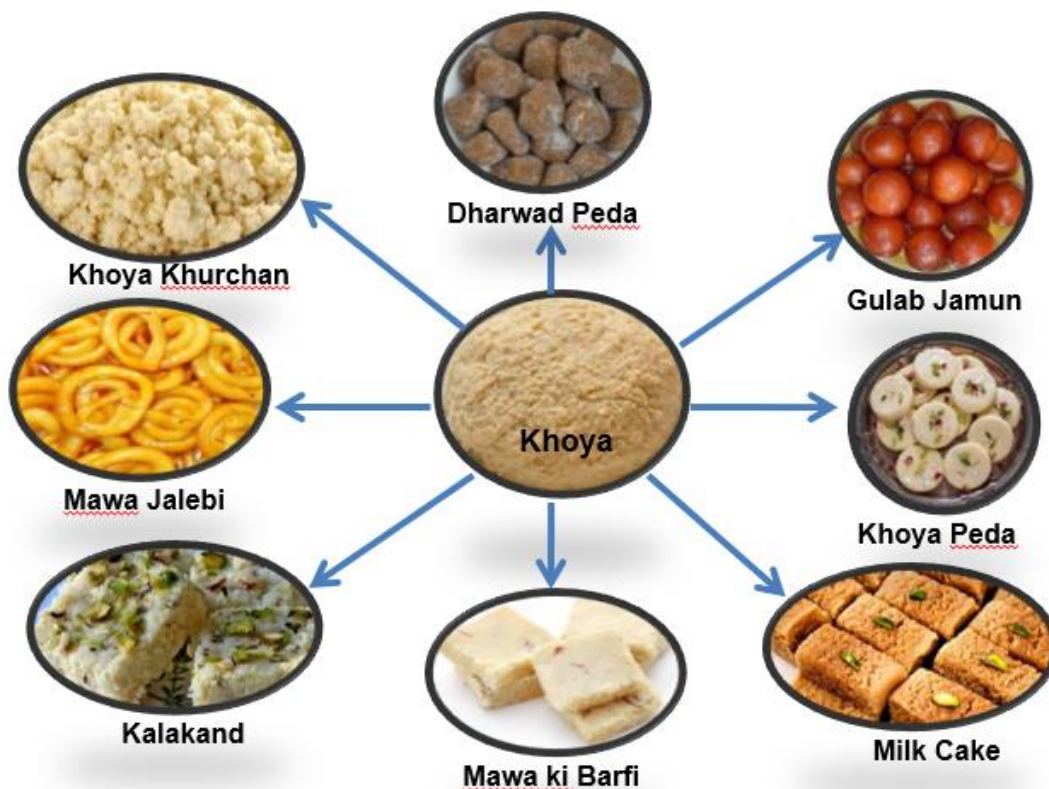

## 2.4 Classification of khoa:

Khoa is classified by the Bureau of Indian Standards into three major types depending upon the specific end uses i.e., pindi, danedar and dhap (IS 4883, 1980).

Type of khoa	TS (%)	Fat (%)	End uses
Dhap	56-63	20-23	Gulabjamun, pantua
Pindi	67-69	21-26	Burfi, peda
Danedar	60-65	20-25	Kalakand, milk cake

(Source: Aneja et al. (2002))

## 2.3 Khoa Processing Flow Chart

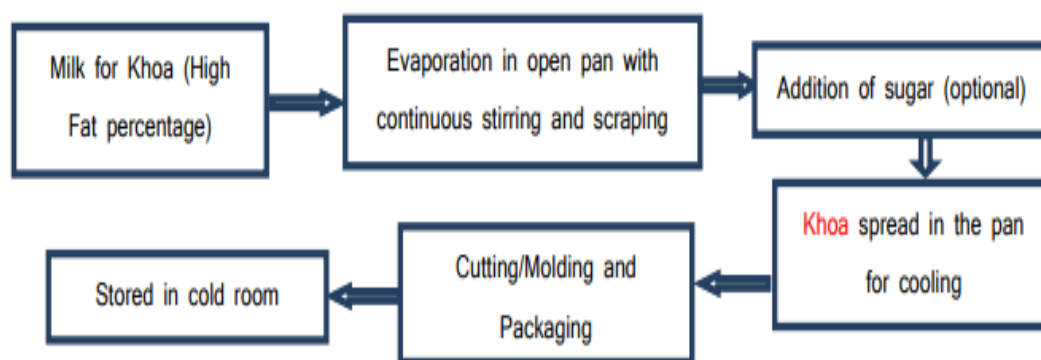

## 2.4 SOP for khoa manufacturing

- Take a representative sample of fresh, normal milk and analyse for sensory as well as chemical attributes.
- The fat level is usually adjusted at 4% level for cow milk and 5% level for buffalo milk.
- Take milk in clean and dry kadai and start simmering over direct nonsmoky fire with constant and vigorous stirring and occasional scrapping to avoid burning.
- Milk thickens with progressive heating and coagulated solidified portion is seen on the heating surface, while liquid milk and air begin to appear on the surface.
- Coagulated particles are brought together with the stirrer and compacted as a semi-solid mass.
- As heating continues, free fat oozes out. From This stage, subsequent heating has a pronounced effect on the development of typical khoa flavour and texture.
- Heating is slowed down, since colour tends to change rapidly at this stage. Temperature is around 8°C and speed of stirring should be 150rpm.
- Gradually, the solid mass tends to leave the heating surface cleanly and a pat is formed.

- Pindi khoa is prepared by heating for longer period while citric acid (about 1.0% of the khoa) is added to prepare Danedar khoa (Granule Khoa).

## 2.5 Ideal Sensory Quality:

**FLAVOUR:** A typical fresh, pleasant, caramelized and mildly cooked flavour similar to that of boiled milk is not acceptable. The taste should be preferably sweet.

**BODY & TEXTURE:** Soft but firm, uniform body and granular texture is most desirable. Pindi Khoa shall have smooth, compact, homogenous texture with very fine grains. Dhap khoa shall have granular texture and slightly soft body. In Danedar khoa, presence of big grains with brown colour is desirable.

**COLOUR & APPEARANCE:** Cow milk khoa shall be pale yellow with a tinge of brown having moist surface, whereas buffalo milk khoa shall be white with a tinge of brown having slightly greasy / oily surface.





## 2.6 Yield:

The yield of khoa mainly depends upon the type of milk used and TS content of milk. It is about 19% from cow milk, 21% from buffalo milk and 20% from standardized milk.

## 2.7 Bureau of Indian Standards (BIS) requirements for Khoa

Characteristic	Requirement		
	Pindi	Danedar	Dhap
Total solids percent by mass, Minimum	65	60	55
Fat, percent by mass (on dry basis), Minimum	37	37	37
Total ash, percent by mass (on dry basis), Maximum	6.0	6.0	6.0
Titratable acidity, (as lactic acid) per cent by mass basis, Maximum	0.8	0.9	0.6
Coliform count per gram, Maximum	90	90	90
Yeast and Mould count per gram, Maximum	50	50	50

## 2.8 Step wise detail of khoa manufacturing

Process Description	Pictorial Representation
Milk Reception in open pan for evaporation	
Boiling and continuous scraping till the volume reduced to one third.	
Boiling and continuous scraping till the volume reduced to one fourth or less.	
Unloading the khoa mass in a tray for cooling and shaping manually	

### 2.8 Uses of Khoa

- Khoa is mainly used in the manufacture of a variety of khoa based sweets like gulabjamun, peda, burfi, kalakand, milk cake etc.
- Khoa is used in the preparation of carrot halwa, palangtod, laddoo etc.
- Khoa is used as a topping for payasam, kaddu ka kheer, other sweets etc.
- Khoa is used for direct consumption after mixing with sugar.

## Chapter – 3

### Packaging

#### 3.1 Selection of packing material for khoa packing

Khoa can be packed in Paper Boxes and stored at two different temperatures 4 and 37 °C. But at 37 °C there can be continuous loss in its moisture. There are various types of khoa available in the market such as Simple khoa, Brown khoa and many more available in different parts of India. They may or may not have different types of packaging.

- a) It is generally packed in paper board containers lined with parchment paper or grease proof paper.
- b) Plastic trays, tubs are used to pack khoa to enhance its marketability.
- c) For polythene bags or parchment paper lined paper board advocated with oxygen scavengers can be used.

#### 3.2 Shelf life of khoa

As we know that khoa main ingredients are milk and sugar. It is prone to get deteriorated over time. Generally, khoa can be kept well for as long as 5-7 days at room temperature. The khoa shelf life may be increased with the help of following:

- a) If it is packed in a multi-layer transparent laminate pouch using the modified atmospheric packing process by injecting N<sub>2</sub> and CO<sub>2</sub> then shelf life can go up to 15 days at normal room temperature and up to 30 days if stored at 20°C.
- b) Khoa samples that are packed in pouches with the use of oxygen scavengers show a greater shelf life of around 2 months at temperature of 37°C and up to 6 months at 20°C.

#### Storage Conditions

- Khoa stored at 37°C was acceptable for up to 9 days and khoa stored at 4°C was acceptable up to 31 days.
- FFA and HMF contents in khoa increased during storage and these changes were found to be temperature sensitive.

## Chapter – 4

### Food Safety Regulations and Standards

#### 4.1 Registration and Licensing of Food Business

All Food Business Operators in the country will be registered or licensed in accordance with the procedures laid down

##### Registration of Petty Food Business

- a. Every petty Food Business Operator shall register themselves with the Registering Authority by submitting
- b. An application for registration in Form A under Schedule 2 of these Regulations along with a fee as provided in Schedule 3.
- c. The petty food manufacturer shall follow the basic hygiene and safety requirements provided in Part I of Schedule 4 of these Regulations and provide a self-attested declaration of adherence to these requirements with the application in the format provided in Annexure-1 under Schedule 2.
- d. The Registering Authority shall consider the application and may either grant registration or reject it with reasons to be recorded in writing or issue notice for inspection, within 7 days of receipt of an application for registration.
- e. In the event of an inspection being ordered, the registration shall be granted by the Registering Authority after being satisfied with the safety, hygiene and sanitary conditions of the premises as contained in Part II of Schedule 4 within a period of 30days.
- f. If registration is not granted, or denied, or inspection not ordered within 7 days as provided in above sub regulation (3) or no decision is communicated within 30 days as provided in above sub regulation (4), the petty food manufacturer may start its business, provided that it will be incumbent on the Food Business Operator to comply with any improvement suggested by the Registering Authority even later.
- g. Provided that registration shall not be refused without giving the applicant an opportunity of being heard and for reasons to be recorded in writing.
- h. The Registering Authority shall issue a registration certificate and a photo identity card, which shall be displayed at a prominent place at all times within the premises or vehicle or cart or any other place where the person carries on sale/manufacture of food in case of Petty Food Business.



- i. The Registering Authority or any officer or agency specifically authorized for this purpose shall carry out food safety inspection of the registered establishments at least once in a year. Provided that a producer of milk who is a registered member of a dairy Cooperative Society registered under Cooperative Societies Act and supplies or sells the entire milk to the Society shall be exempted from this provision for registration.

## **4.2 Hygienic, Sanitary and Good Manufacturing Practices (GMP/GHP)**

In addition to Part-II, the dairy establishment in which dairy-based food is being handled, processed, manufactured, stored, distributed and ultimately sold by the food business operator, and the persons handling them should conform to the sanitary and hygienic requirement, food safety measures and other standard as specified below.

1. Sanitary requirements
  - a. Facilities for the hygienic handling and protection of raw materials and of non-packed or non-wrapped dairy products during loading and unloading, transport & storing including Bulk Milk cooling facilities.
  - b. Special watertight, non-corrodible containers to put raw materials or dairy products intended for human consumption. Where such raw materials or dairy products are removed through conduits, these shall be constructed and installed in such a way so as to avoid any risk of contamination of other raw materials or dairy products;
  - c. A waste water disposal system which is hygienic and approved;
  - d. Facilities for cleaning & disinfecting of tanks used for transporting dairy products and raw milk. These containers have to be cleaned after every use.
  - e. The occupier of a dairy establishment shall take appropriate measures to avoid cross-contamination of dairy products in accordance with the cleaning program as specified in point 9.1 of Part II.
  - f. Where a dairy establishment produces food stuffs containing dairy products together with other ingredients, which have not undergone heat treatment or any other treatment having equivalent effect, such dairy products and ingredients, shall be stored separately to prevent cross-contamination.
  - g. The production of heat-treated milk or the manufacture of milk-based products, which might pose a risk of contamination to other dairy products, shall be carried out in a clearly separated working area.

- h. Equipment, containers and installations which come into contact with dairy products or perishable raw materials used during production shall be cleaned and if necessary disinfected according to a verified and documented cleaning programme.
- i. Equipment, containers, instruments and installations which come in contact with microbiologically stable dairy products and the rooms in which they are stored shall be cleaned and disinfected according to a verified and documented. Food Safety management programme drawn up by the owner/occupier of the dairy establishment.
- j. Disinfectants and similar substances used shall be used in such a way that they do not have any adverse effects on the machinery, equipment, raw materials and dairy products kept at the dairy establishment. They shall be in clearly identifiable containers bearing labels with instructions for their use and their use shall be followed by thorough rinsing of such instruments and working equipment with potable water, unless supplier's instructions indicate otherwise.

## 2. Personal hygiene requirements

- a. The Food Business Operator shall employ those persons only in such an establishment to work directly with and handle raw materials or dairy products if those persons have proved to the occupier's satisfaction by means of a medical certificate, on recruitment, that there is no medical impediment to their employment in that capacity.
- b. Persons working directly with and handling raw materials or dairy products shall maintain the highest standards of personal cleanliness at all times. In particular they shall
  - wear suitable, clean working clothes and headgear which completely encloses their hair;
  - Wash their hands at least each time work is resumed and whenever contamination of their hands has occurred; e.g., after coughing / sneezing, visiting toilet, using telephone, smoking etc.
  - (Cover wounds to the skin with a suitable waterproof dressing. No person with injury on hand, even with dressing, shall be placed in any product making/handling section.
  - avoid certain hand habits - e.g., scratching nose, running finger through hair, rubbing eyes, ears and mouth, scratching beard, scratching parts of bodies etc. that are potentially hazardous when associated with handling dairy products, and might lead to food contamination through the transfer of bacteria from the



employee to product during its preparation. When unavoidable, hands should be effectively washed before resuming work after such actions

### 3. Sanitary requirements for storage

- a. Immediately after procuring, raw milk shall be placed in a clean place, which is suitably equipped so as to prevent any kind of contamination.
- b. The cans/ containers made up of mild steel metal and plastic material used for storage and transportation of milk and milk products shall not be allowed.
- c. If raw milk is brought to the dairy plant by a producer or farmer then it shall be ensured that he brings it within four hours of milking and it shall be cooled as soon as practicable to a temperature of 4°C or lower and maintained at that temperature until processed.
- d. Where raw milk is collected daily from a producer, it shall be cooled immediately to a temperature of 4°C to 6°C or lower and maintained at that temperature until processed;
- e. When the pasteurization process is completed, pasteurized milk shall be cooled immediately to a temperature of 4°C or lower. Subject to Paragraph 7 below, any dairy product not intended to be stored at ambient temperature shall be cooled as quickly as possible to the temperature established by the manufacturer of that product as suitable to ensure its durability and thereafter stored at that temperature.
- f. Where dairy products other than raw milk are stored under cooled conditions, their storage temperatures shall be registered and the cooling rate shall be such that the products reach the required temperature as quickly as possible.
- g. The maximum temperature at which pasteurized milk may be stored until it leaves the treatment establishment shall not exceed 5°C.

### 4. Wrapping and packaging

- a. The wrapping and packaging of dairy products shall take place under satisfactory hygienic conditions and in rooms provided for that purpose.
- b. The manufacture of dairy products and packaging operations may take place in the same room if the following conditions are satisfied:
  - The room shall be sufficiently large and equipped to ensure the hygiene of the operations;

- the wrapping and packaging shall have been brought to the treatment or processing establishment in protective cover in which they were placed immediately after manufacture and which protects the wrapping or packaging from any damage during transport to the dairy establishment, and they shall have been stored there under hygienic conditions in a room intended for that purpose;
  - The rooms for storing the packaging material shall be free from vermin and from dust which could constitute an unacceptable risk of contamination of the product and shall be separated from rooms containing substances which might contaminate the products. Packaging shall not be placed directly on the floor;
  - packaging shall be assembled under hygienic conditions before being brought into the room, except in the case of automatic assembly or packaging, provided that there is no risk of contamination of the products;
  - packaging shall be done without delay. It shall be handled by separate group of staff having experience in handling and product wrapping and
  - immediately after packaging, the dairy products shall be placed in the designated rooms provided for storage under required temperature.
- c. Bottling or filling of containers with heat-treated milk and milk product shall be carried out hygienically.
- d. Wrapping or packaging may not be re-used for dairy products, except where the containers are of a type which may be re-used after thorough cleaning and disinfecting.
- e. Sealing shall be carried out in the establishment in which the last heat-treatment of milk or liquid milk-based products have been carried out, immediately after filling, by means of a sealing device which ensures that the milk is protected from any adverse effects of external origin on its characteristic. The sealing device shall be so designed that once the container has been opened, the evidence of opening remains clear and easy to check.

### **4.3 Packaging and Labelling**

The packaging design and materials shall provide protection for products in order to prevent contamination, damage and accommodate required labelling as laid down under the FSS Act and the Regulations there under. Only food grade packaging materials shall be used

as primary packaging material. Packaging materials like aluminium, tin and plastic shall conform to the Indian standards as mentioned under the FSS Regulations from time to time. The food packaging materials shall be inspected before use to avoid using damaged, defective or contaminated packaging, which may lead to contamination of the product.

- The wrapping and packaging of dairy products shall take place under satisfactory hygienic conditions and in rooms provided for that purpose.
- The rooms for storing the packaging material shall be free from vermin and from dust which could constitute an unacceptable risk of contamination of the product and shall be separated from rooms containing substances which might contaminate the products. Packaging shall not be placed directly on the floor.
- Packaging shall be done without delay followed by labelling. If it is not the case, appropriate procedure shall be applied to ensure that no mix-ups or mislabelling could occur. It shall be handled by separate group of staff having experience in handling and product wrapping and immediately after packaging; the dairy products shall be placed in the designated rooms provided for storage under required temperature.
- Packaging material/wrapping materials shall be protected from external environment/contamination during transport and storage. Facilities shall be established for safe and hygienic storage of packing materials at the dairy plant.”
- Wrapping or packaging may not be re-used for dairy products, except where the containers are of a type which may be re-used after thorough cleaning and disinfecting.
- “Packaging of milk and milk products shall be carried after processing. The packages should be designed so as to ensure they are tamper proof and are not easily damaged during general handling /operation. Once the packages are opened it should be easily identifiable and cannot be duplicated against a fresh/unopened package”.
- The ink used for printing of primary food packaging should be of food grade quality. This should comply with **IS 15495** standards or other international standards for use in food packaging and printing.

#### **4.4 Coding and Labelling of Packaging Material**

Fluid milk: The caps of the milk bottles /pouch/aseptic pack shall clearly indicate the nature of the milk contained in them. The indication may be either in full or by abbreviation shown below:

- i) Buffalo milk may be denoted by the letter ‘B’.
- ii) Cow milk may be denoted by the letter ‘C’

- iii) Goat milk may be denoted by the letter ‘G’
- iv) Standardized milk may be denoted by the letter ‘S’
- v) Toned milk may be denoted by the letter ‘T’
- vi) Double toned milk may be denoted by the letter ‘DT’
- vii) Skimmed milk may be denoted by the letter ‘K’
- viii) Pasteurised milk may be denoted by the letter ‘P; followed by the class of milk. For example, Pasteurised Buffalo milk shall bear the letters ‘PB ‘.
- ix) Alternatively, suitable indicative colours of the packs/caps/bags shall be indicative of the nature of milk contained in them, the classification of colours being displayed at places where milk is sold\stored or exhibited for sale, provided that the same had been simultaneously intimated to the concerned Designated Officer, and information disseminated through the local media

#### **4.5 Exemptions from labelling requirements**

Where the surface area of the package is not more than 100 square centimetres, the label of such package shall be exempted from the requirements of list of ingredients, Lot Number or Batch Number or Code Number, nutritional information and instructions for use, but this information shall be given on the wholesale packages or multi piece packages, as the case may be.

1. The 'date of manufacture' or 'best before date' or 'expiry date' may not be required to be mentioned on the package having surface area of less than 30 square centimetres but this information shall be given on the wholesale packages or multi piece packages, as the case may be;
2. In case of liquid products marketed in bottles, if such bottle is intended to be reused for refilling, the requirement of list of ingredients shall be exempted, but the nutritional information specified in regulation 2.2.2 (4) these regulations shall be given on the label. Provided that in case of such glass bottles manufactured after March 19, 2009, the list of ingredients and nutritional information shall be given on the bottle.
3. “To make a fluid not below the composition of toned milk or skimmed milk (as the case may be) with the contents of this package, add (here insert the number of parts) of water by volume to one part by volume of this condensed milk or desiccated (dried) milk”.
4. In case of food with shelf-life of not more than seven days, the 'date of manufacture' may not be required to be mentioned on the label of packaged food articles, but the 'use by date' shall be mentioned on the label by the manufacturer or packer.

5. In case of multi piece packages the particulars regarding list of ingredients, nutritional information, Date of manufacture/ packing, best before, expiry date labelling of irradiated food and, vegetarian logo/non vegetarian logo, may not be specified.

#### **4.6 Date of manufacture or packing**

The date, month and year in which the commodity is manufactured, packed or pre-packed, shall be given on the label:

Provided that the month and the year of manufacture, packing or pre-packing shall be given if the “Best Before Date” of the products is more than three months:

Provided further that in case any package contains commodity which has a short shelf life of less than three months, the date, month and year in which the commodity is manufactured or prepared or pre-packed shall be mentioned on the label.

#### **Best Before and Use By Date**

- i) the month and year in capital letters up to which the product is best for consumption, in the following manner, namely:

“BEST BEFORE ..... MONTHS AND YEAR

OR

“BEST BEFORE ..... MONTHS FROM PACKAGING

OR

“BEST BEFORE .....MONTHS FROM MANUFACTURE

(Note: — blank be filled up)

- ii) In case of package or bottle containing sterilised or Ultra High Temperature treated milk, soya milk, flavoured milk, any package containing bread, dhokla, bhelpuri, pizza, doughnuts, khoa, paneer, or any un canned package of fruits, vegetable, meat, fish or any other like commodity, the declaration be made as follows

“BEST BEFORE .....DATE/MONTH/YEAR”

OR

“BEST BEFORE.....DAYS FROM PACKAGING”

OR

“BEST BEFORE .....DAYS FROM MANUFACTURE”

**Note:**

(a) blanks be filled up

(b) Month and year may be used in numerals (c) Year may be given in two digits

(iii) On packages of Aspartame, instead of Best Before date, Use by date/recommended last consumption date/expiry date shall be given, which shall not be more than three years from the date of packing;

(iv) In case of infant milk substitute and infant foods instead of Best Before date, Use by date/recommended last consumption date/expiry date shall be given, Provided further that the declaration of best before date for consumption shall not be applicable

#### **4.7 Documentation and Record Keeping**

Every organization has to maintain records of raw material procurement, production processes, and sales. This is to ensure that the business runs effectively and is profitable. Listed below are some reasons why there is a need for documentation:

1. It gives detailed knowledge about running the business.
2. It helps to control product quality.
3. It helps to keep track of the money invested in the business.
4. It helps to identify the separate costs of raw material or product ingredients.
5. It helps to identify the production cost of a particular process.
6. It helps to make sure that all the quality assurance practices were followed during the production.
7. It helps to make sure that the production equipment is running smoothly/effectively.
8. It works as an evidence for legal procedures.
9. It helps to set an appropriate product price.
10. It helps to take corrective measures at the right time.

#### **4.8 How to Keep Records?**

Every food processing organization follows a more or less similar way of keeping records.

Production records keep a log of the following:

- The quantity and type of raw materials received
- The quantity and type of ingredients used during processing
- The processing conditions in which production took place (e.g., the temperature set or the air pressure applied)
- The product quality produced

Product quality can be maintained only when:

- The same quantity and quality of ingredients and raw materials are mixed in every batch
- A standard formulation is used for every batch
- Standard process parameters are applied for every batch

Every batch of food is given a batch number. This number is recorded in:

- Stock control books (where raw material procurement is noted)
- Processing logbooks (where production process is noted)
- Product sales records (where sales and distribution is noted)

The batch number must correlate with the product code number, which is printed on labels. This helps the processor to trace any fault found in a batch back to the raw material used or the production process.

## Chapter – 5

### Cleaning and CIP

#### 5.1 Tanker Washing

The main objective of this unit is to clean the tankers properly after unloading or before uploading milk or any other dairy ingredients to avoid microbial and bacterial growth.

##### Stepwise washing operation:

- Circulate Caustic solution for 15min. (1 – 1.5%) at 70 – 75<sup>0</sup>C.
- Flush out Caustic with water.
- Circulate with hot water for 15min. (80 – 85<sup>0</sup>C)
- Allow temperature to cool down
- Get QA clearance

#### 5.2 Crate Washing:

Normally a semi-automatic crate washer is used for cleaning the crates. The washer cleans the crates in stages

Solid waste removal – Manually

1. Pre-rinse
2. Hot water and caustic solution
3. Final rinsing

#### 5.3 CIP of raw milk tank, multipurpose tank etc.

- Flush Silo with necessary water
- Clean (by brushing) the door of the manhole and sampling point with soap oil and water.
- Circulate Caustic solution for 20min. (1 – 1.5%) at 70 – 75<sup>0</sup>C.
- Flush out Caustic with water.
- Circulate with acid for 20min. (0.6 – 1.0%) at 60 – 65<sup>0</sup>
- Circulate with hot water for 20min. (80 – 85<sup>0</sup>C)
- Allow temperature to cool down



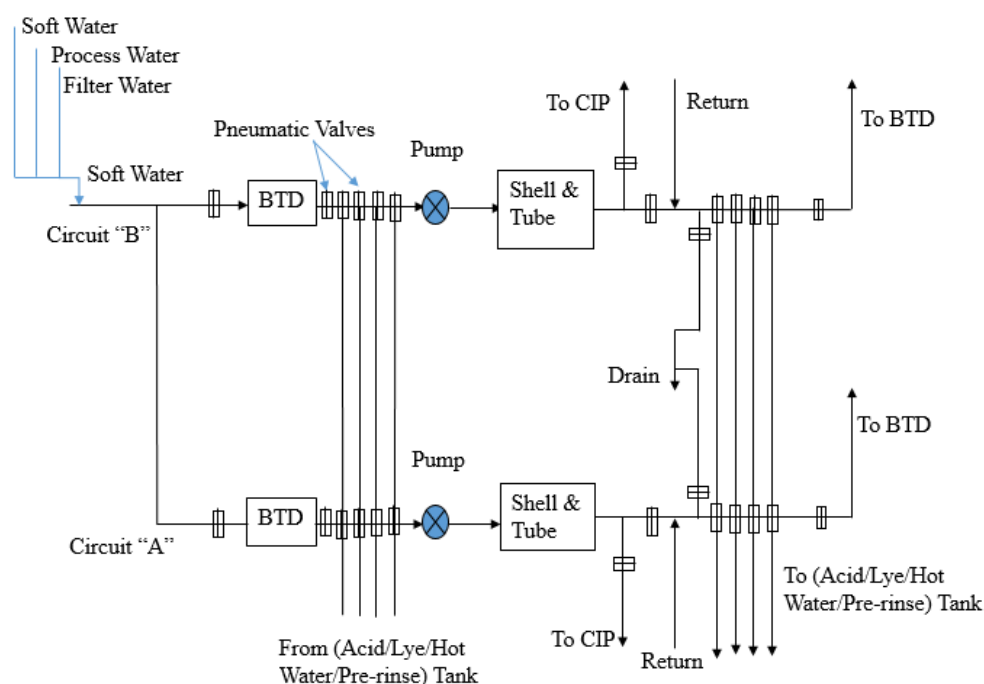

Fig: A two station CIP Circuit(model)

## 5.4 Effluent Treatment Plant (ETP)

ETP is a 24 hrs. continuous process. It takes hazardous outlet from all the process as inlet, treat it in three stages (Primary, Secondary and Tertiary stage) to reach the environmental standard. The outlets of the plant namely solid waste and treated water are respectively disposed in field and used for irrigation purpose in plant to develop green belt.

### Effluent Sources:

1. CIP: Caustic and Nitric Acid
2. Backwash: Water
3. Tanker wash: Caustic and Nitric Acid
4. Boiler: Water
5. Caret wash: Caustic

### Stepwise description of ETP functioning:

- 1) Screen chamber: Raw effluent from the plant is received by screen chamber and suspended particles are removed here.

- 2) Collection and equalization tank: After the screening the effluent enters the collection and equalization tank, where it is neutralized with hydrochloric acid and the effluent is made homogeneous.
- 3) Holding tank: It only meant for storage when excess amount of effluent is discharged from plant during CIP
- 4) Dissolved Air Flootation (DAF): The neutralized effluent from collection and equalization tank is received here and aluminum sulphate (a non-ferric alum) is added. The suspended and emulsified solids are separated here.
- 5) Buffer tank: It is an over flow storage tank
- 6) Up blow Anaerobic Suspended Sludge Blanket (UASSB) Reactor (I&II): 12% to 15% of the total volume of this tank is filled with biomass. It receives the effluent from DAF from the bottom of the tank. There are two type of bacteria present here.
  - a. Acetogenesis: - It converts the large chain molecule to small chain molecule and produces amino acid.
  - b. Methenogenesis: - It converts to methane gas, and hence organic load decreases
- 7) Hopper bottom tank: It is just a tank to control the escaped microbes from UASSBR and again recirculate it.
- 8) Aeration tank: In this tank aerobic microbes are developed
- 9) Lamella clarifier: It is used for solid settling purpose i.e. the solid liquid separation takes place here
- 10) Secondary clarifier: Here the aerobic culture is settled and again circulated to aeration tank to maintain the amount.
- 11) Treated water tank: Here the treated water from secondary clarifier or lamella clarifier is collected.

### **5.5 Plant Performance and Monitoring:**

- Carryout regular monitoring program involving maintenance of record and analysis of effluent sample.
- ETP assistants have to collect samples at different stages of treatment system in presence of ETP in-charge for analysis.
- ETP in-charge has to do the analysis and record the result also report the result to EHS-engineer and EHS-officer. EHS-engineer and EHS-officer both will assess the performance of the plant based on laboratory analysis report and instruct the ETP in-charge and assistants about the action to be taken in case of any deviation from normal.

- The treated effluent has to be analyzed on daily basis and the results are recorded

## **5.6 Environmental Management System (EMS): Implementation and operation:**

- 2. Level-1:** EMS manual; describes the core elements of the EMS and their interactions. It outlines the structure of the document used in the EMS in line with-ISO 14001-2004 manual also describe the procedures elaborately how various requirements of ISO 14001-2004 are implemented.
- 3. Level-2:** Documents; the filled formats which conveys the data that affects the environment. Ex – Operational control process, environmental management programs, emergency procedures, monitoring and management plans, training plan etc.
- 4. Level-3:** Formats; used for recording and conveying data effecting the environment